

RU

GB

INSTALLATION MANUAL
SKID PLATE FOR ENGINE BAY AND TRANSMISSION CASE



RENAULT Master 2,3 MT FWD

2010 - 

18.4671/18.4672

17/12/20

1/7



RU /
GB Location/Position Arrow

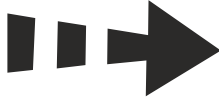

RU
GB Movement Arrow



RU
GB Screw Arrow

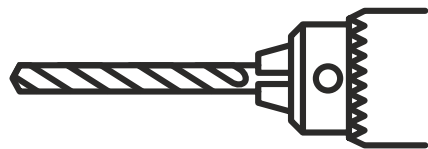
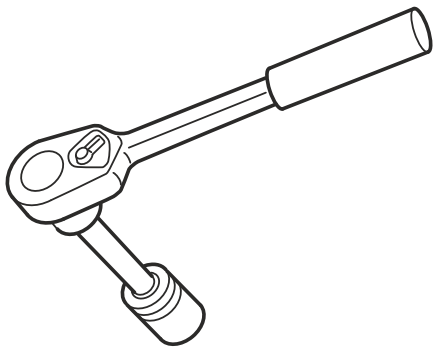
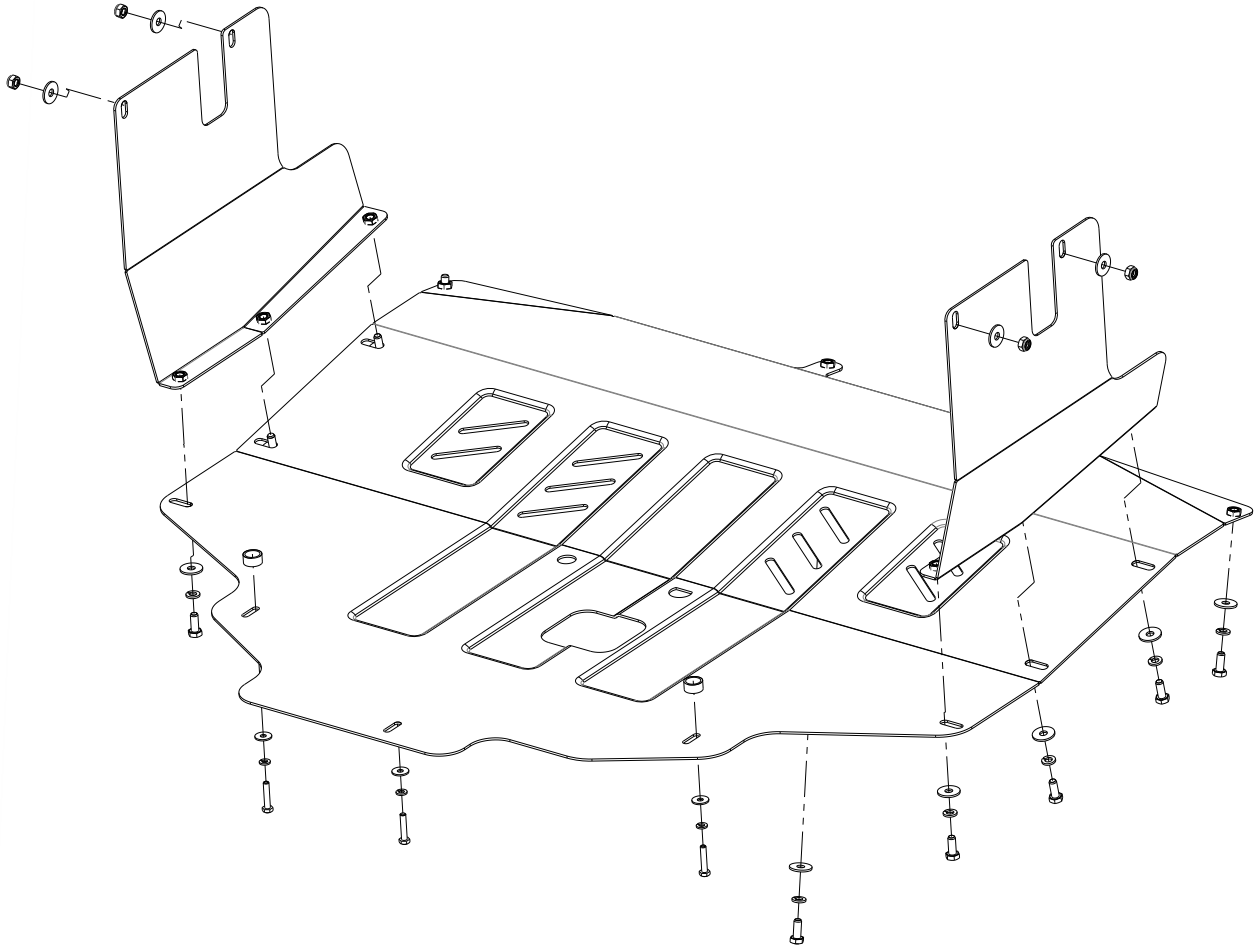

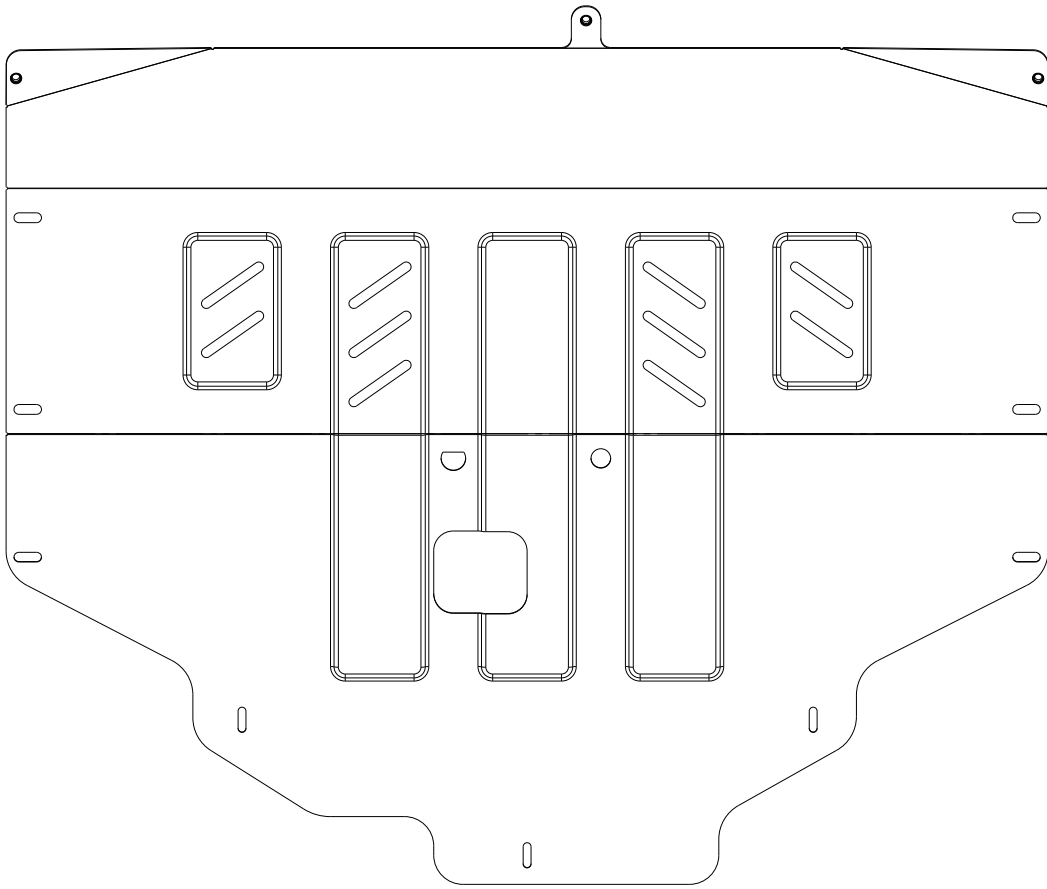
A

1X

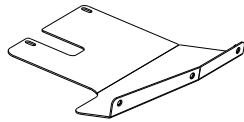
B

1X

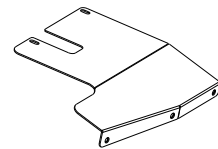

1X

D

20001

2X

E

M6 30

3X

F

8

4X

G

M8 20

9X

H

Ø6

3X

I

Ø6

3X

J

Ø8

9X

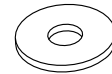
K

Ø8

13X

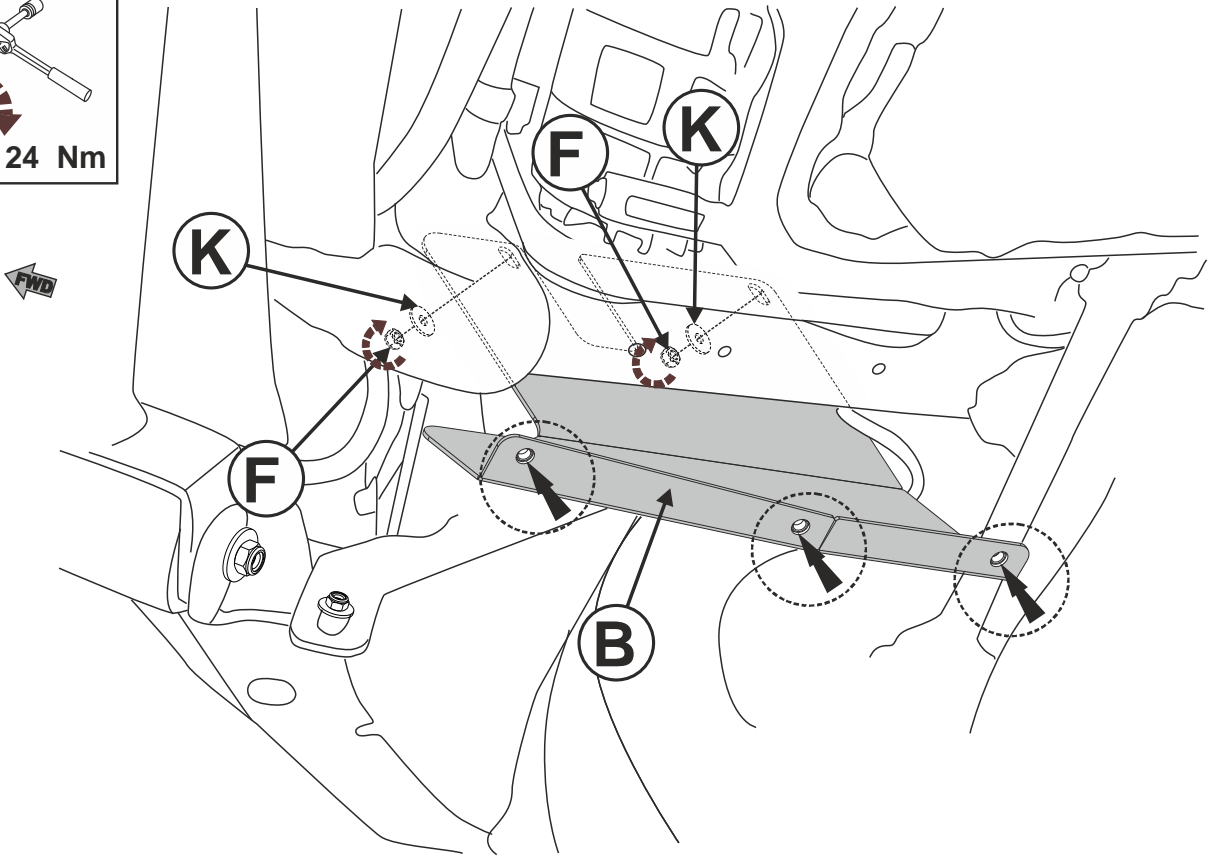
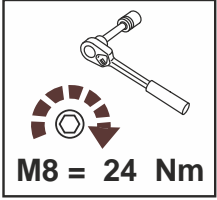

1

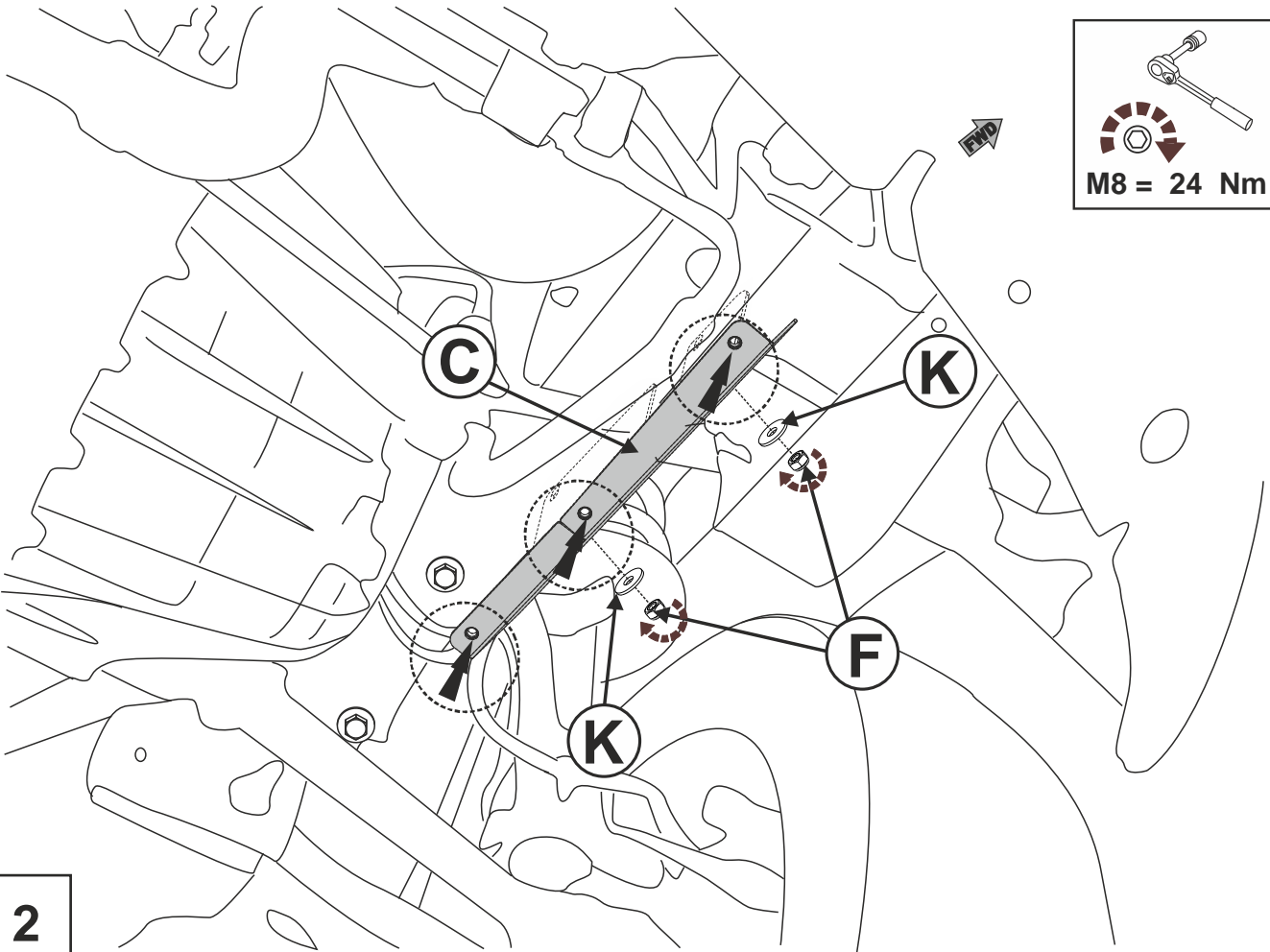
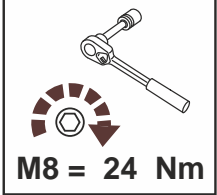

2

